

この組合せは学校で配布した物と試合番号は異なっていますが、対戦相手は同じです。

## タイムテーブル

8月19日

	1	2	3	4	5	6	7	8
9:20	2BS1	2BS2	2BS3	2BS4	2BS5	2BS6	2BS7	2BS8
9:35	2BS9	2BS10	2BS11	2BS12	2BS13	2BS14	2BS15	2BS16
9:50	2GS1	2GS2	2GS3	2GS4	2BS17	2BS18	2BS19	2BS20
10:05	2BS21	2BS22	2BS23	2BS24	2BS25	2BS26	2BS27	2BS28
10:20	2BS29	2BS30	2BS31	2BS32	2BS33	2BS34	2BS35	2BS36
10:35	2BS37	2BS38	2BS39	2BS40	2BS41	2BS42	2BS43	2BS44
10:50	2BS45	2BS46	2BS47	2BS48	2GS5	2GS6	2GS7	2GS8
11:05	2GS9	2GS10	2GS11	2GS12	2GS13	2GS14	2GS15	2GS16
11:20	2GS17	2GS18	2GS19	2GS20	2GS21	2GS22	2GS23	2GS24
11:35	2GS25	2GS26	2GS27	2GS28	2GS29	2GS30	2GS31	2GS32
11:50	2GS33	2GS34	2GS35	2GS36	2BS49	2BS50	2BS51	2BS52
12:05	2BS53	2BS54	2BS55	2BS56	2BS57	2BS58	2BS59	2BS60
12:20	2BS61	2BS62	2BS63	2BS64	2GS37	2GS38	2GS39	2GS40
12:35	2GS41	2GS42	2GS43	2GS44	2GS45	2GS46	2GS47	2GS48
12:50	2GS49	2GS50	2GS51	2GS52	2BS65	2BS66	2BS67	2BS68
13:05	2BS69	2BS70	2BS71	2BS72	2GS53	2GS54	2GS55	2GS56
13:20	2GS57	2GS58	2GS59	2GS60	1BS1	1BS3	1BS4	1BS5
13:35	1BS6	1BS7	1BS8	1BS9	1GS1	1GS2	1GS3	1GS4
14:10	1GS5	1GS6	1GS7	1BS2	2BS73	2BS74	2BS75	2BS76
14:45	2GS61	2GS62	2GS63	2GS64	1BS10	1BS11	1BS12	1BS13
15:20	1GS8	1GS9	1GS10	1GS11	2BS77	2BS78	2GS65	2GS66
15:55	1BS14	1BS15	1GS12	1GS13	2BS79	2BS80	2GS67	2GS68
16:30	1BS16	1BS17	1GS14	1GS15				

※3年生の集合12:30

8月21日

	1	2	3	4	5	6	7	8
9:20	2GD1	2GD2	2GD3	2GD4	2BD1	2BD2	2BD3	2BD4
9:35	2BD5	2BD6	2BD7	2BD8	2BD9	2BD10	2BD11	2BD12
9:50	2BD13	2BD14	2BD15	2BD16	2BD17	2BD18	2BD19	2BD20
10:05	2BD21	2BD22	2BD23	2BD24	2BD25	2BD26	2BD27	2BD28
10:20	2BD29	2BD30	2GD5	2GD6	2GD7	2GD8	2GD9	2GD10
10:35	2GD11	2GD12	2GD13	2GD14	2GD15	2GD16	2GD17	2GD18
10:50	2GD19	2GD20	2GD21	2GD22	2GD23	2GD24	2GD25	2GD26
11:05	2GD27	2GD28	2GD29	2GD30	2GD31	2GD32	2GD33	2GD34
11:20	2GD35	2GD36	2BD31	2BD32	2BD33	2BD34	2BD35	2BD36
11:35	2BD37	2BD38	2BD39	2BD40	2BD41	2BD42	2BD43	2BD44
11:50	2BD45	2BD46	2GD37	2GD38	2GD39	2GD40	2GD41	2GD42
12:05	2GD43	2GD44	2GD45	2GD46	2GD47	2GD48	2GD49	2GD50
12:20	2GD51	2GD52	1BD1	1GD1	2BD47	2BD48	2BD49	2BD50
12:35	2BD51	2BD52	2BD53	2BD54	2GD53	2GD54	2GD55	2GD56
12:50	2GD57	2GD58	2GD59	2GD60	1BD2	1BD3	1BD4	1BD5
13:35	1GD2	1GD3	1GD4	1GD5	2BD55	2BD56	2BD57	2BD58
14:20	2GD61	2GD62	2GD63	2GD64	1BD6	1BD7	1GD6	1GD7
15:05	2BD59	2BD60	2GD65	2GD66	1BD8	1BD9	1GD8	1GD9
15:50	2BD61	2BD62	2GD67	2GD68				

※3年生の集合12:00

※両日とも、ベスト4決め(黒字)以降21点3ゲームマッチ、  
それまでは21点1ゲームマッチ、ともに延長あり。時間等に変更あり。

# 男子1部シングルス

1/1

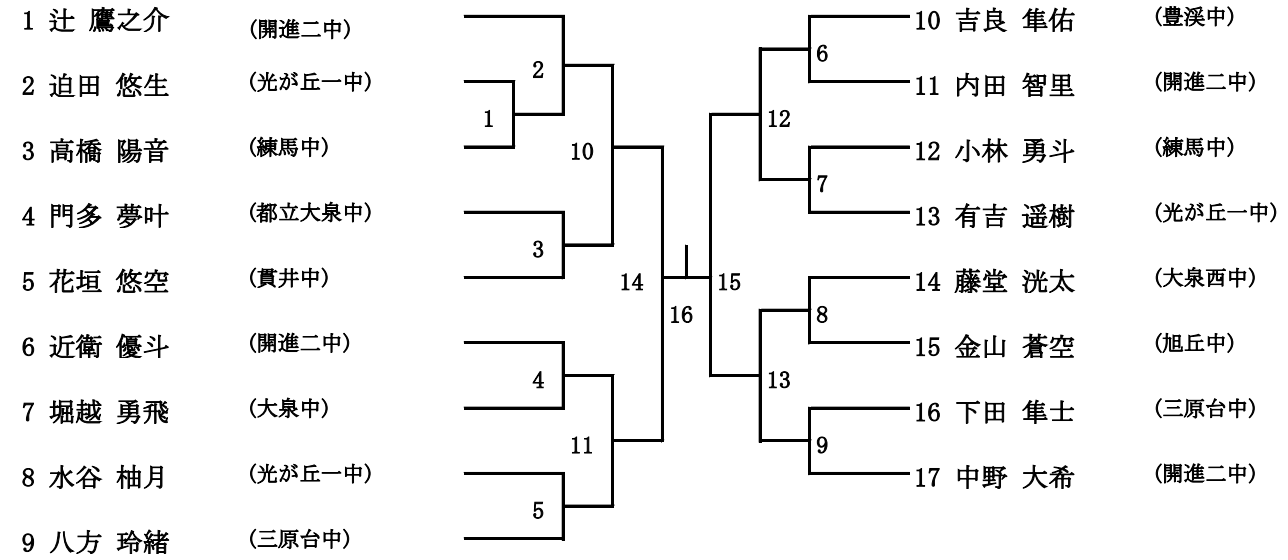

## 3位決定戦

( )  
( )

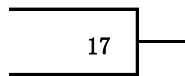

# 女子1部シングルス

1/1

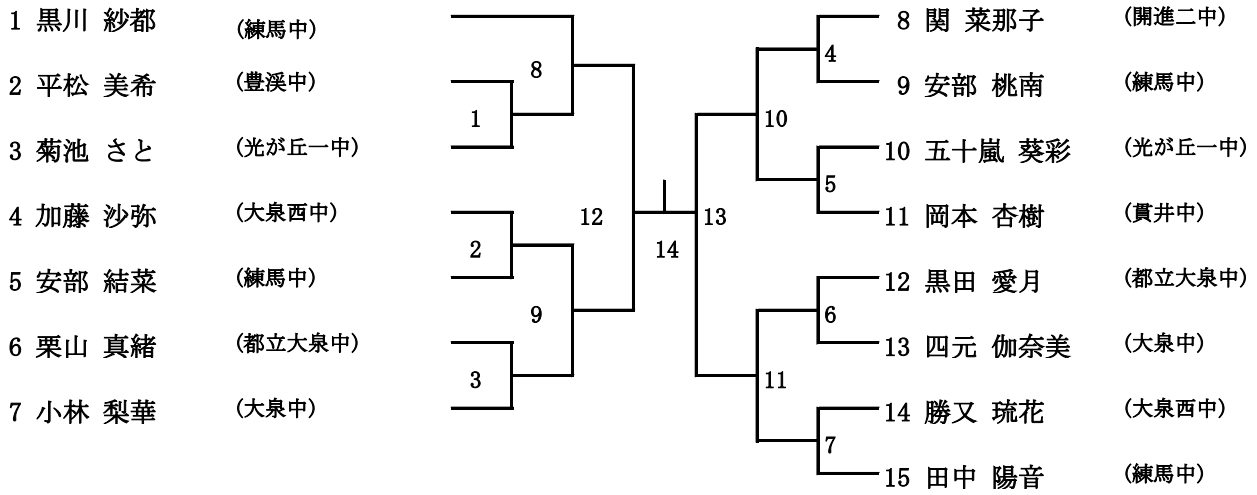

## 3位決定戦

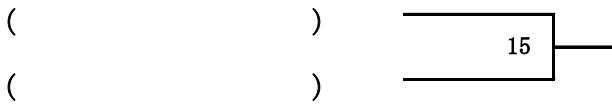

# 男子2部シングルス

1/2

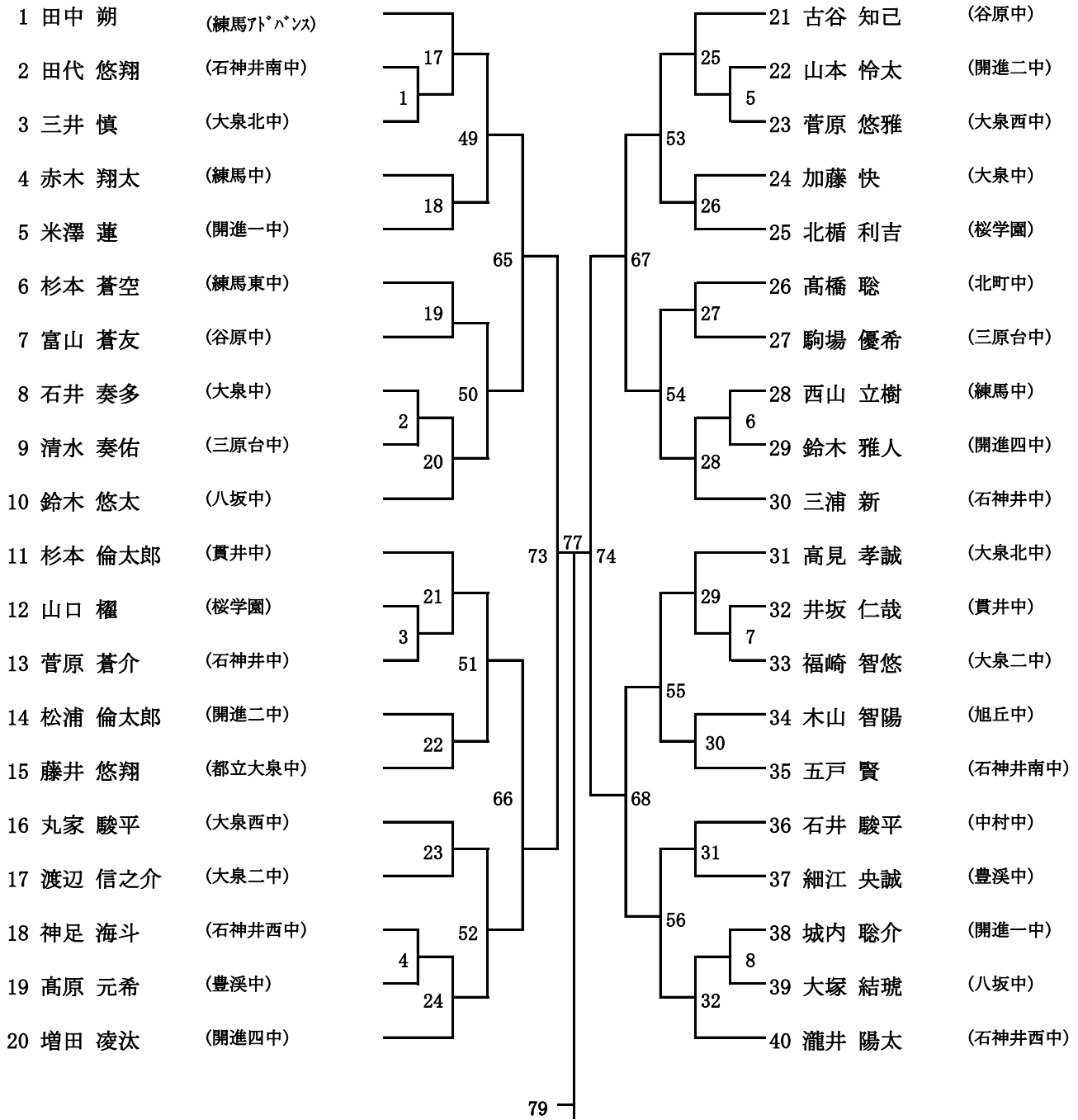

3位決定戦

( )

( )

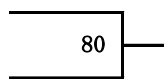

# 男子2部シングルス

2/2

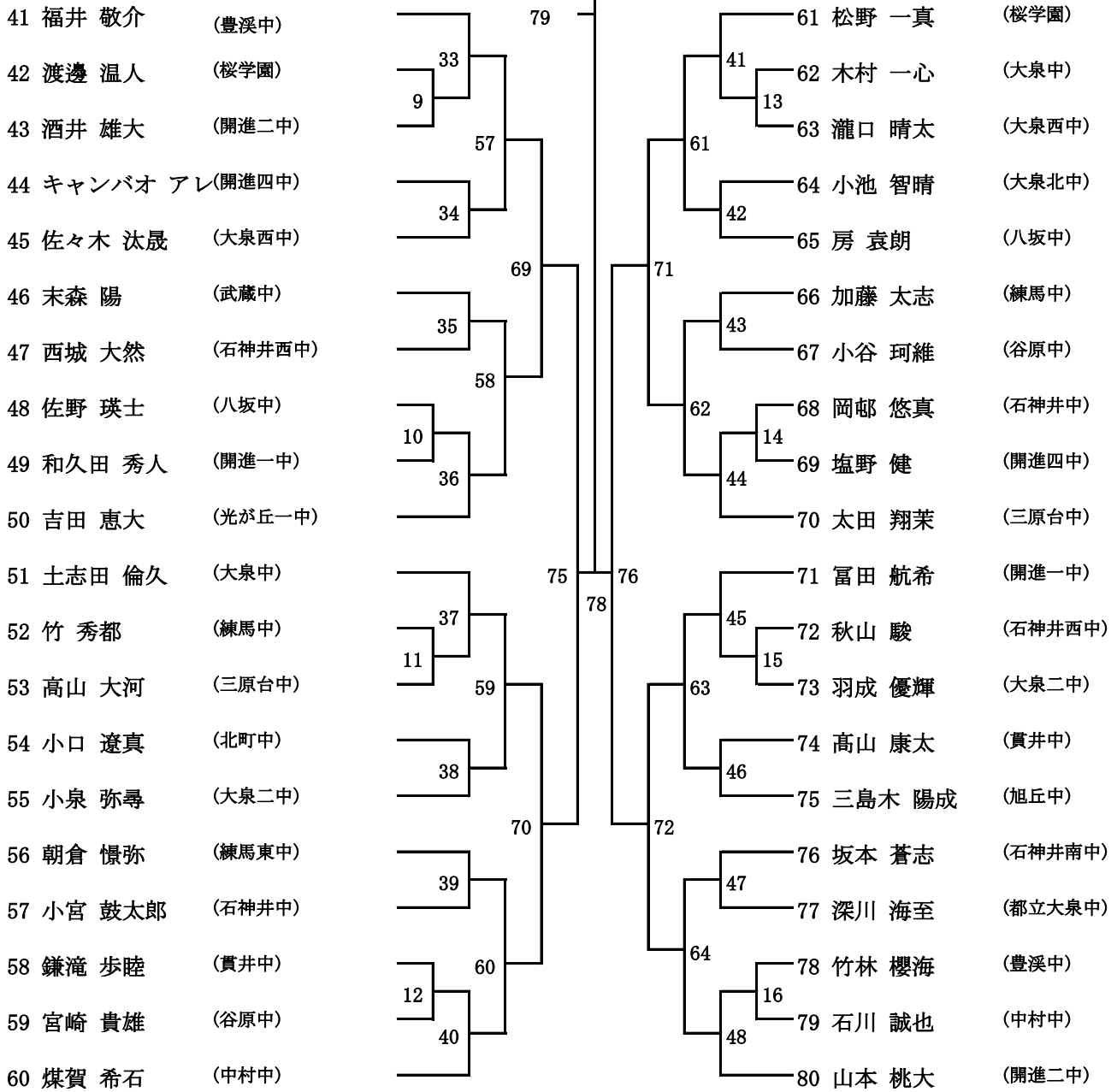

# 女子2部シングルス

1/2

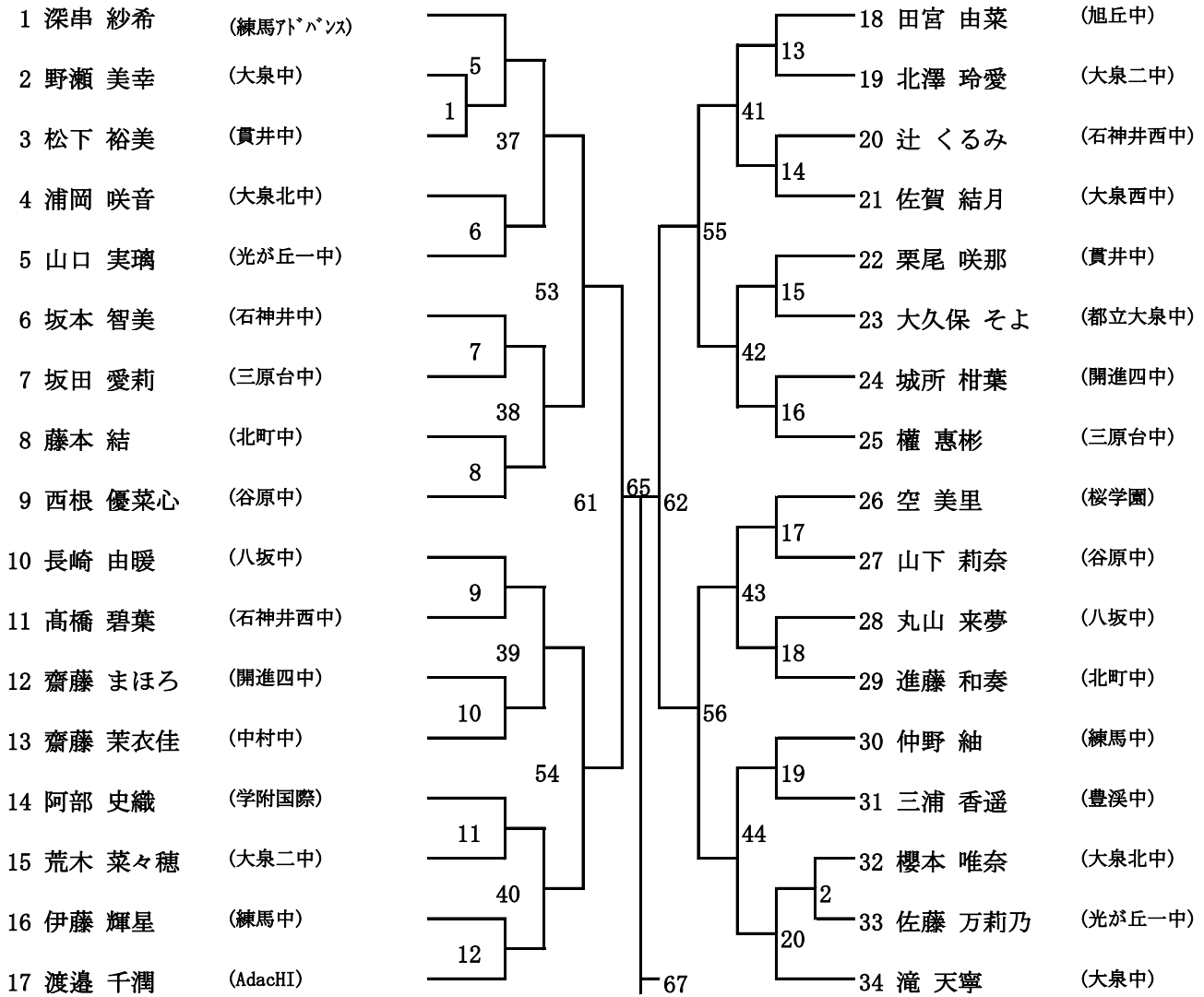

## 3位決定戦

( )  
( )

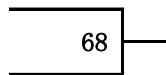

# 女子2部シングルス

2/2

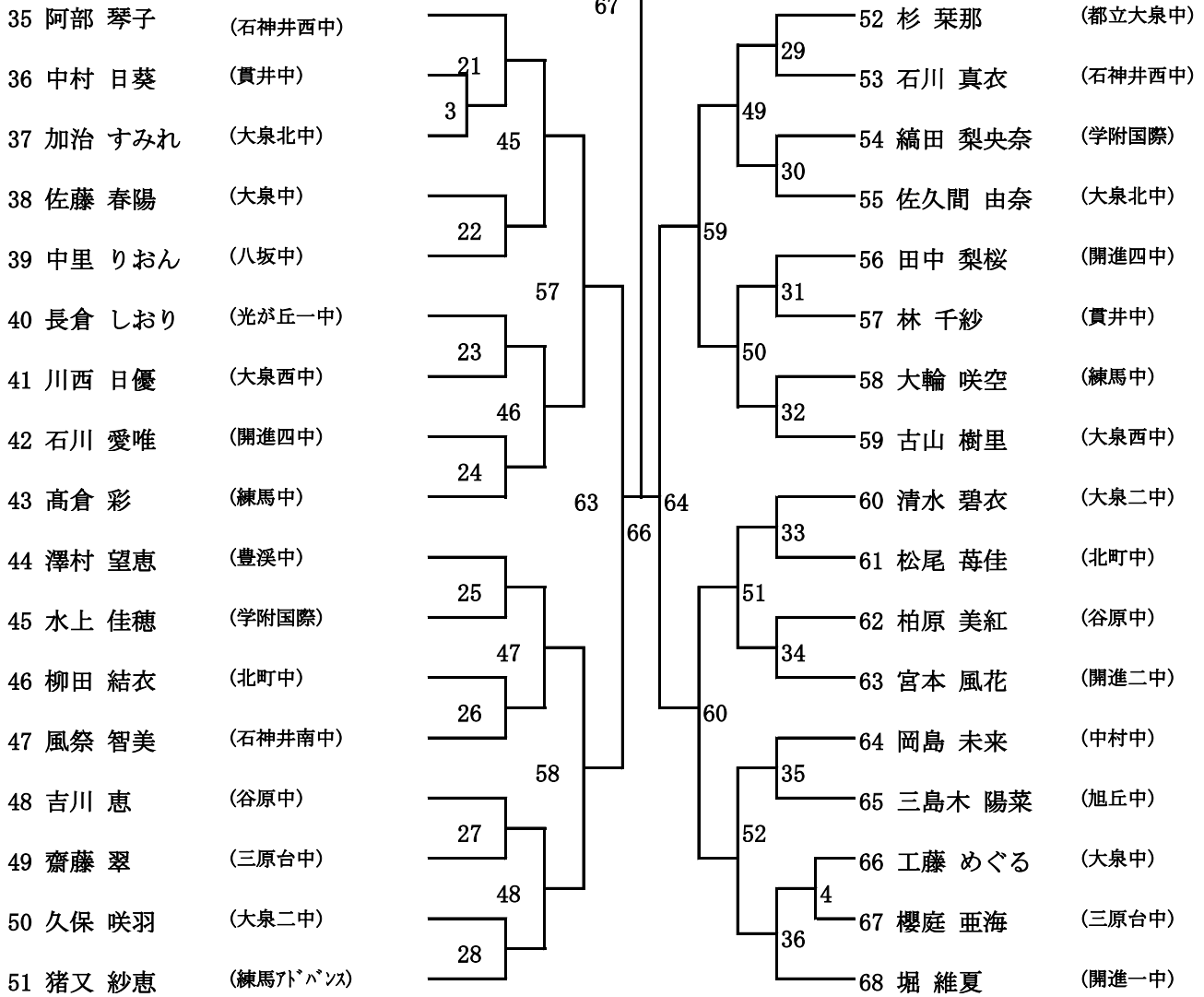



# 男子 1 部ダブルス

1/1

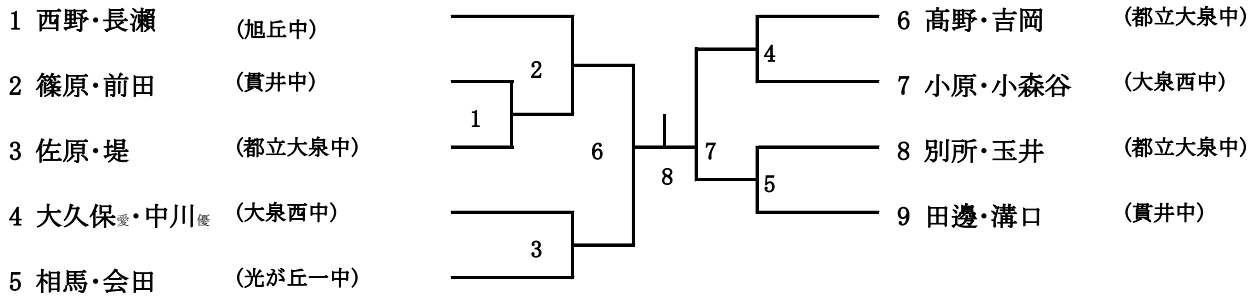

## 3位決定戦

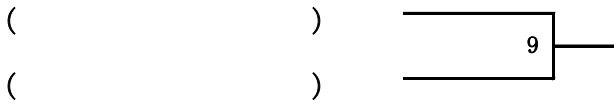

# 女子1部ダブルス

1/1

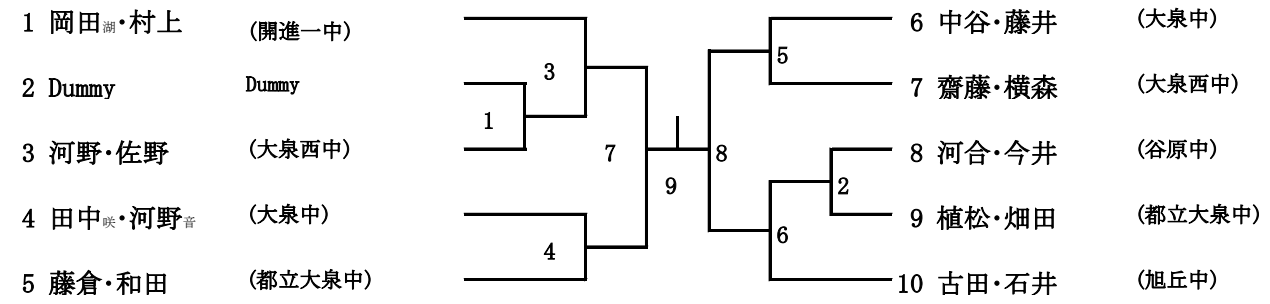

## 3位決定戦

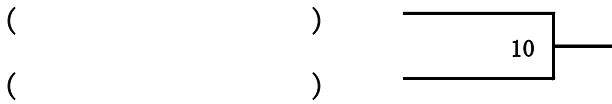

# 男子2部ダブルス

1/2

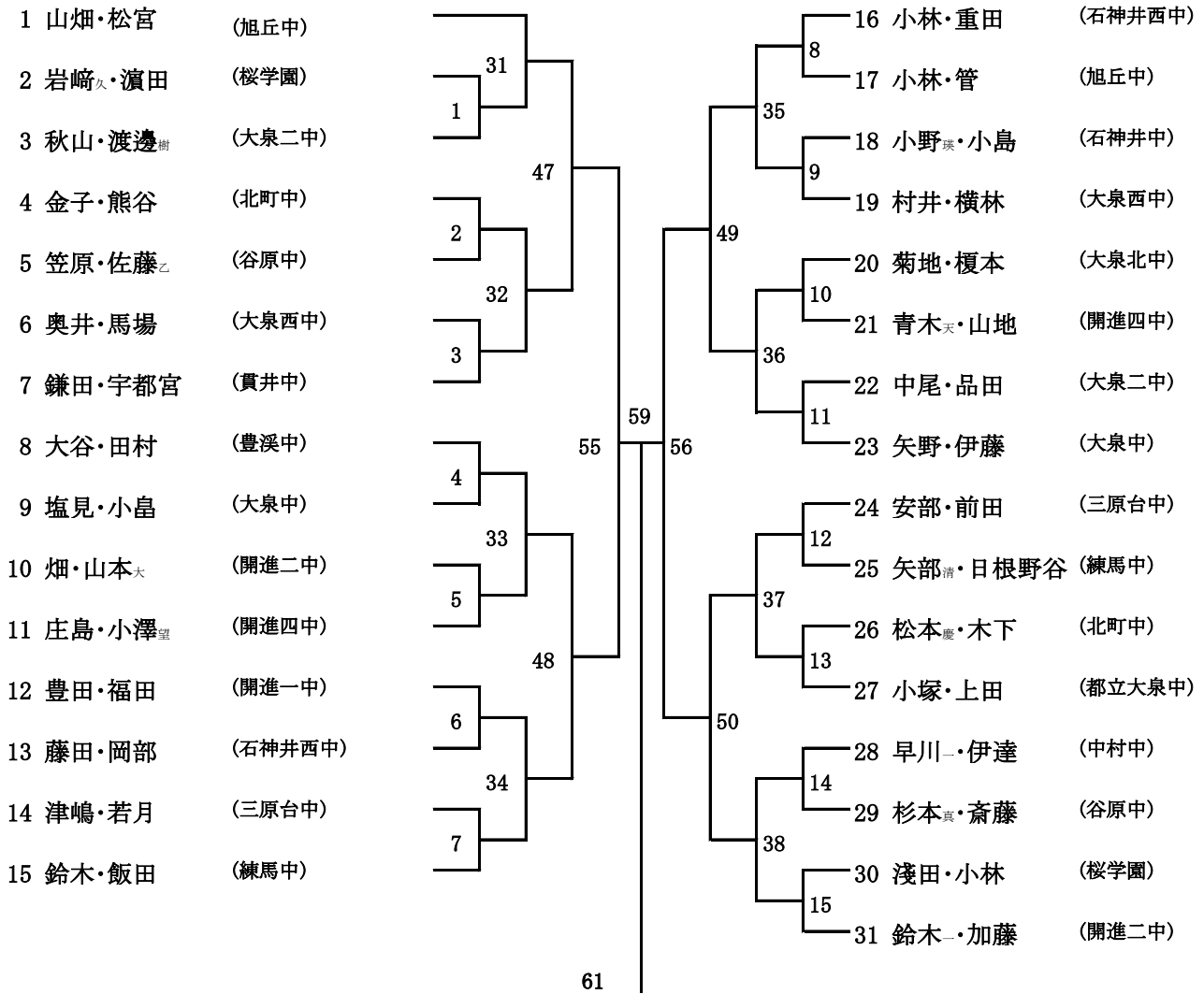

## 3位決定戦

( )

( )

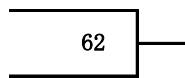

# 男子 2部ダブルス

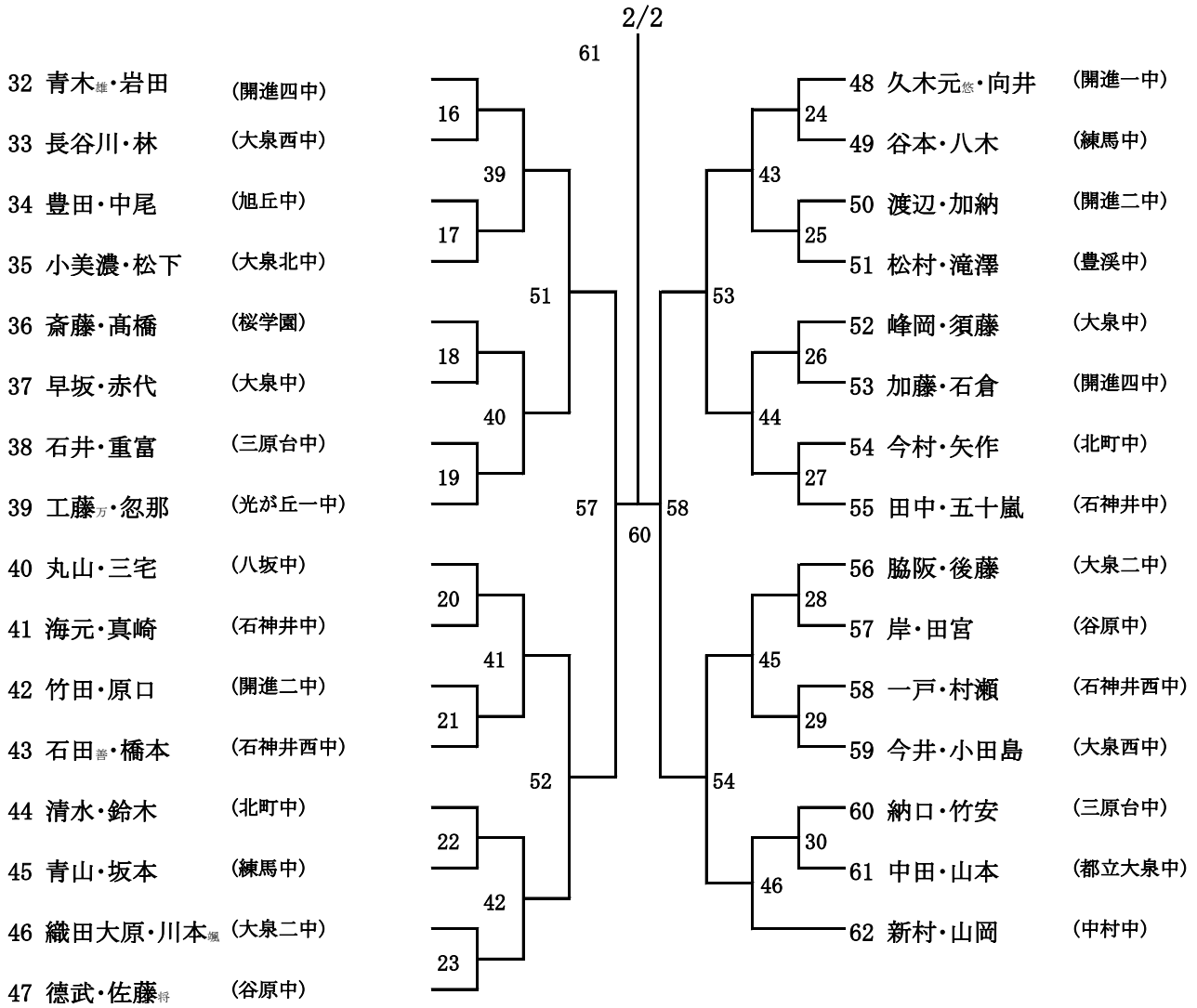

# 女子2部ダブルス

1/2

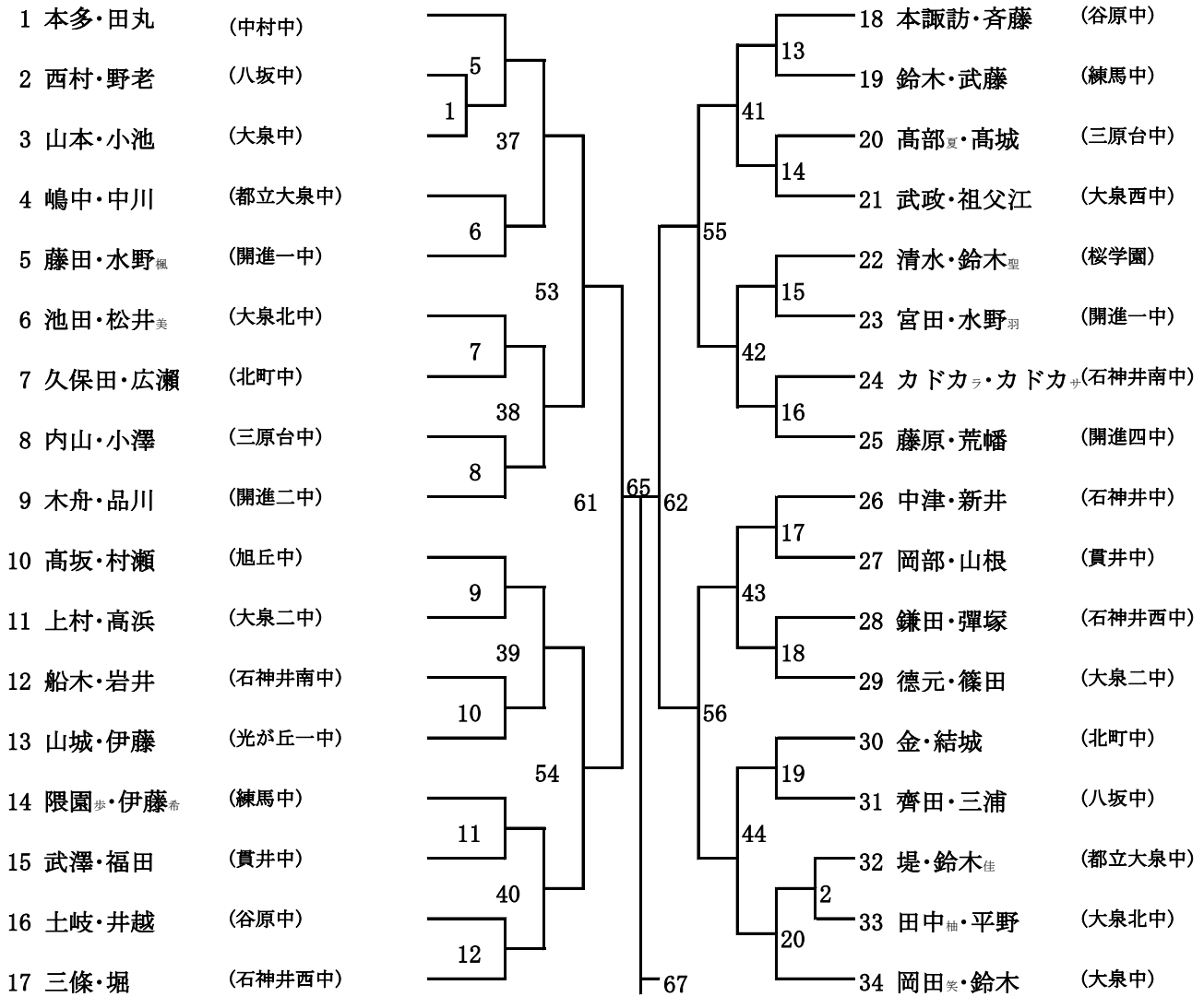

## 3位決定戦

( )  
( )

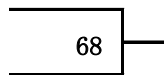

# 女子2部ダブルス

2/2

